

# KNX DALI Gateway

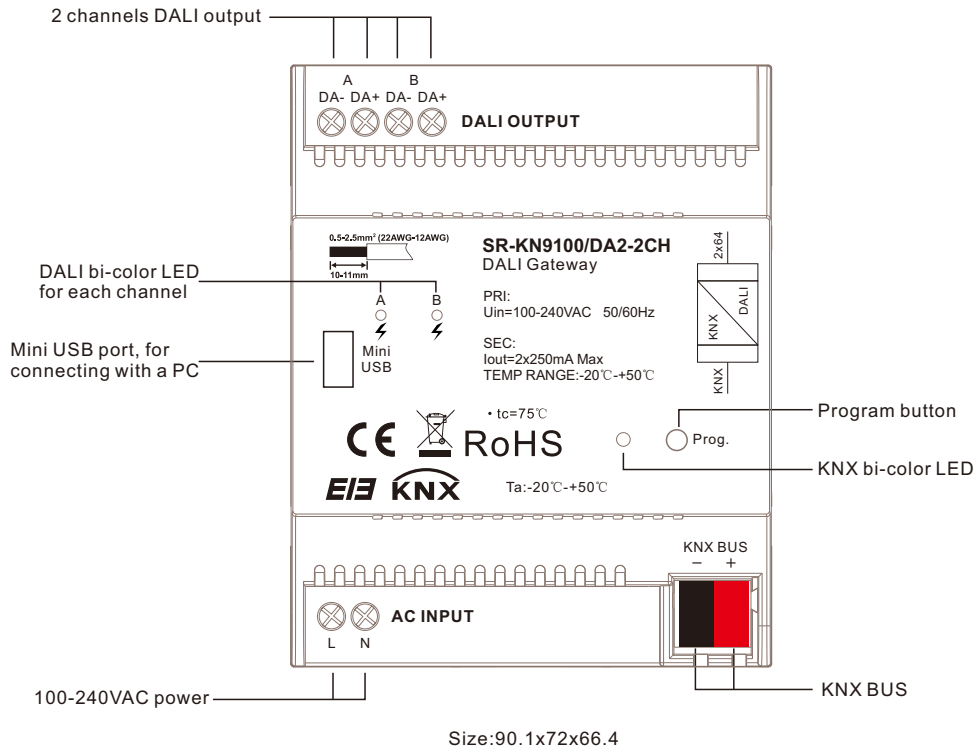

**Important:** Read All Instructions Prior to Installation

## Function introduction



## Product Description

The KNX DALI Gateway is a DIN rail module for installation in the distribution board on a 35 mm mounting rail. It is a DALI single-master controller to DALI standard IEC 62386 Parts 101ed2 and 103ed1. The gateway is suitable for use with DALI and DALI-2 systems.

It supports Device Type 6, Device Type 8 Tc, Device Type 8 XY coordinate, Device Type 8 RGB with DALI interfaces to IEC 62386 and their integration in a KNX building installation.

The DALI gateway has 2 channels DALI output. Up to 64 DALI devices can be connected to each DALI output. DT6 and DT8 devices can all be connected to each DALI output in a mixed configuration. The lamps connected to each DALI channels are controlled via KNX using:

- broadcast
- 64 individual lamps
- 16 lighting groups
- 16 scenes

The fault status (lamps or ballasts) of each DALI device or of the lighting group is sent via the KNX bus by a variety of KNX group objects.

In addition to the standard functions, e.g. switching, dimming and brightness value setting with the corresponding feedback, the DALI Gateway offers the function Scene. The lighting groups or individual lamps can be integrated in an energy-efficient building automation system via a KNX presence detector or light controller.

The DALI Gateway features the Tunable White (Tc) color function, which allows you to set and dim the color temperature of lamps (DT8). There are also settings options for the additional Human Centric Lighting (HCL) functions.

The DALI Gateway is designed with wide range supply voltage input. Each channel is integrated with a 250mA DALI power supply. No additional DALI power supply is required and wiring is simplified.

DALI commissioning can be executed via DALI Master PC software, and KNX commissioning can be executed via ETS5.

## Technical data

Supply	Gateway supply voltage	100-240VAC, 50/60Hz
	Total current draw from mains	Maximum 48mA
	Total power consumption via mains	Maximum 11W
	KNX Bus voltage	21-30V DC, via the KNX/EIB bus
	KNX current consumption	Maximum 10mA
DALI outputs	Power consumption via KNX	Maximum 210mW
	Number of outputs	2
	Number of DALI devices	Maximum 64 per output
	Supported device types	DT6, DT8 Tc, DT8 XY coordinate, DT8 RGB
	DALI voltage	Typical 16VDC
	Maximum supply current	2x250mA
Connections	KNX	KNX connection terminal, 0.8 mm Ø, solid
	DALI outputs & mains voltage	Screw terminal, 0.5-2.5 mm Ø, stranded
	Mini USB	USB-A to Mini USB data cable (USB 2.0)
Operation and display	KNX Button and red LED	For assigning the physical address
	KNX Green LED flashing	Indicate the application layer running normally
	DALI red LED on	Indicate DALI fault
	DALI green LED on	Indicate DALI bus running normally
Type of protection	IP 20, EN 60 529	
Temperature	Operation	-5 °C...+45°C
	Storage	-25 °C...+55°C
	Transport	-25 °C...+70°C
Ambient	Humidity	<93%, except dewing
Design	Dimensions	90.1x72x66.4mm
Mounting	On 35mm mounting rail	To EN60715

## Application Programming

To program the KNX DALI gateway, DALI part and KNX part need to be programmed separately. To program DALI part, the DALI PC configuration software "DALI Master" will be required. To program KNX part, the "ETS5" software will be required.

# DALI Programming

## 1. Wiring and Preparation

Do wiring according to the wiring diagram and power on. Download and install the latest DALI PC configuration software "DALI Master", the version should be V1.52 or later.

## 2. Addressing DALI Devices

Run "DALI Master" PC software, and follow operations as shown in the figures below to address DALI devices. The KNX DALI gateway has 2 channels, each channel has to address connected DALI devices separately. Here we take Bus #1 as an example, addressing operation of Bus #2 is the same as Bus #1.

2.1. Once the "DALI Master" PC software is running, the 2 channels DALI will be discovered and shown on the left of the window automatically, then click to choose "Bus #1" on the left as shown in Figure 1.

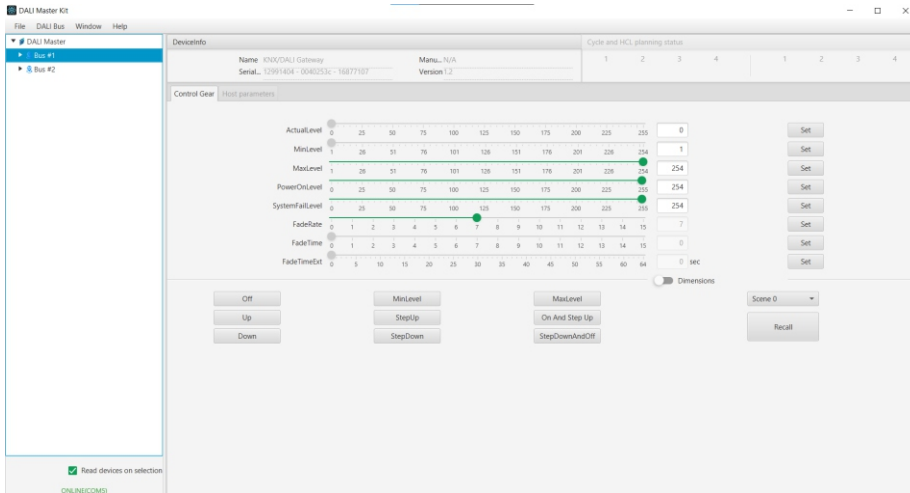

Figure 1

2.2. Click on "DALI Bus" to drop down the menu, then click to choose "Addressing" as shown in Figure 2.

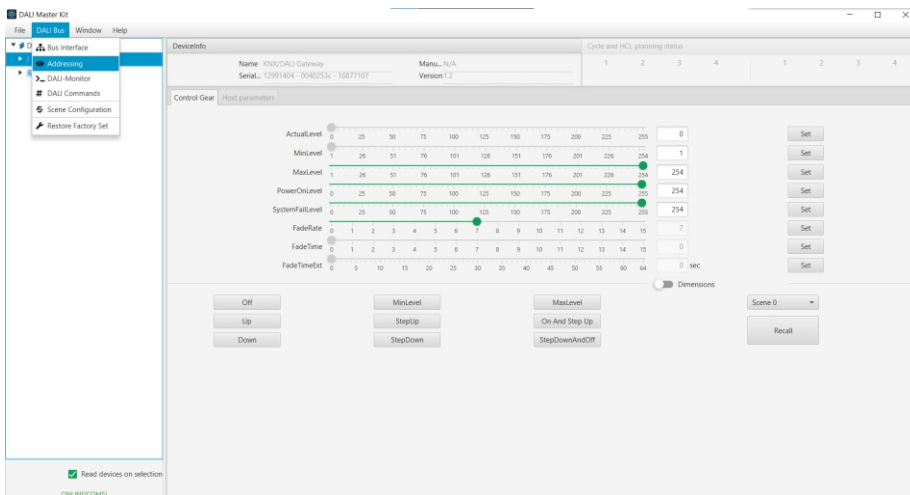

Figure 2

2.3. The DALI addressing setting window will pop up, if it is totally new installation, just choose "Complete new installation" and tick to choose "Control Gears" and leave other options not chosen, then click on "Next" to start addressing as shown in Figure 3.

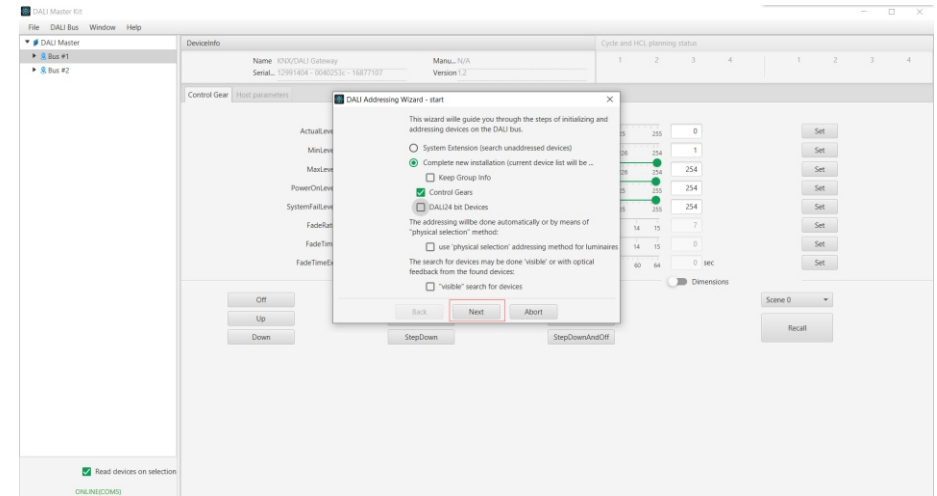

Figure 3

Note: If current installation just adds some control gears to the DALI bus, and previously installed control gears on the DALI bus have already been addressed, and you would like to keep their configuration, just choose "System Extension" and tick to choose "Keep Group Info" and "Control Gears", and leave other options not chosen. Then addressing will only be executed to the newly added control gears.

2.4. The DALI addressing process will start as shown in Figure 4.

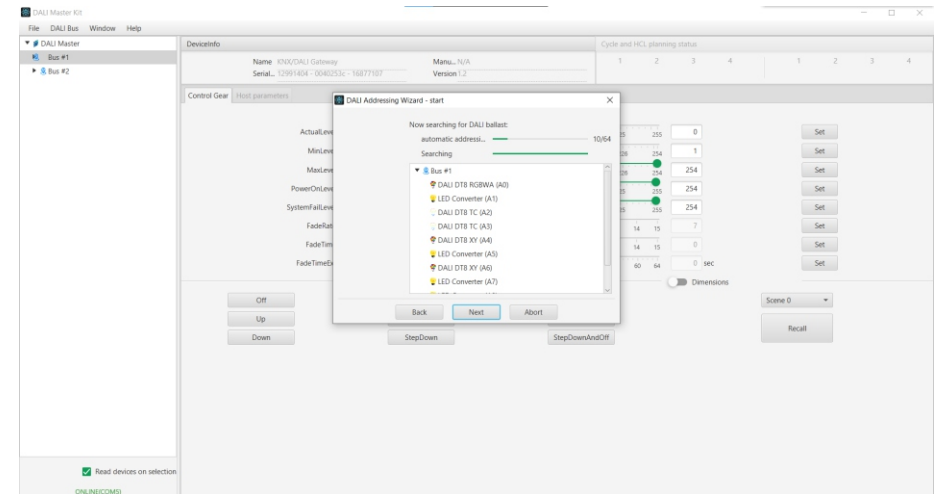

Figure 4

Note: Please do not click on any button until the addressing is completed.

2.5. Once the window shows “Search for devices finished”, addressing is completed, click on “Done” button as shown in Figure 5. Then all control gears on Bus #1 will be listed on the left column of the main window under Bus #1.

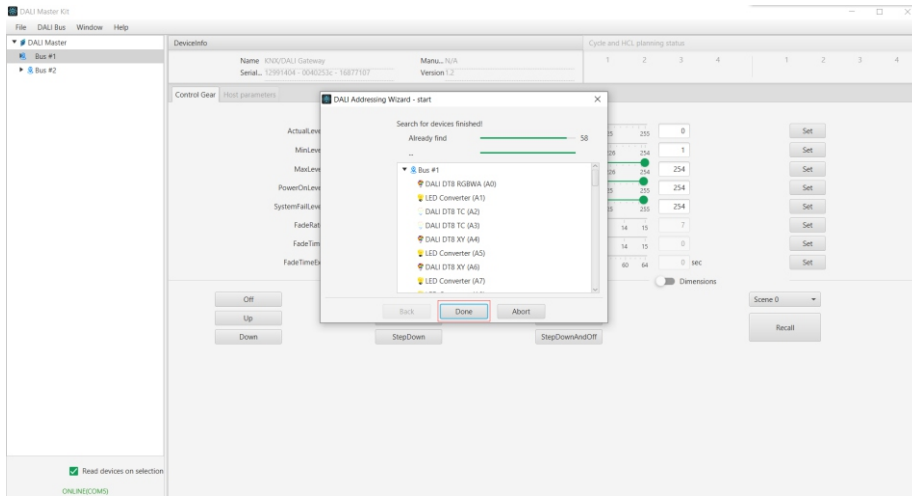

Figure 5

2.6. For addressing of DALI devices on Bus #2, please refer to the operations of Bus #1.

### 3. Assigning DALI Devices to DALI Groups

3.1. Click to choose a DALI Device under Bus #1 on the left column of main window, the DALI configuration parameters of this device will be shown on the right side. The configuration item “Member of Groups” is to assign the device to maximum 16 DALI groups. Click on the group number 0-15, the group number background color will change to green, which means the device is assigned to this DALI group. Click the green color group number again, its background color will change to gray, which means the device is removed from this DALI group. As shown in Figure 6, 7, 8 & 9.

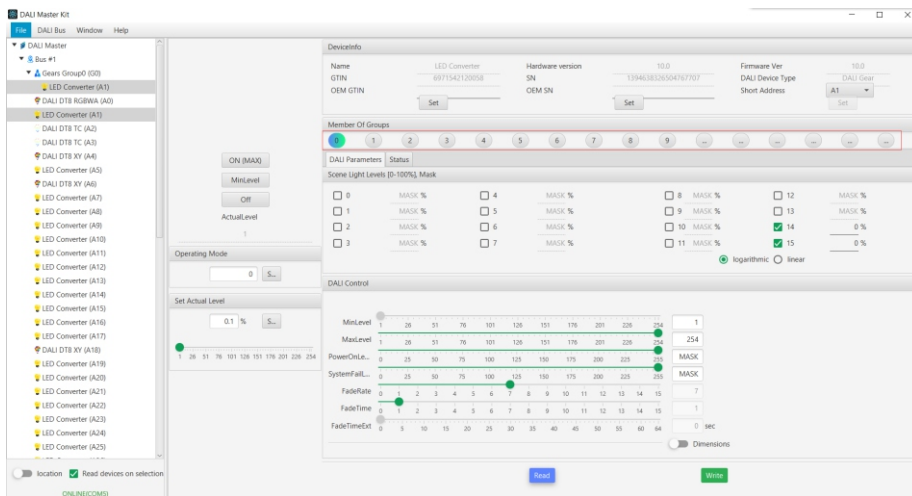

Figure 6 DALI Group Configuration for DT6 Device

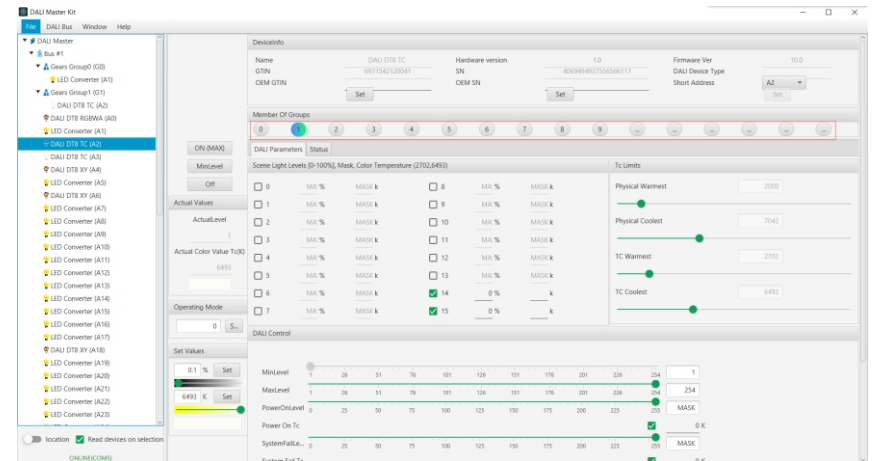

Figure 7 DALI Group Configuration for DT8 Tc Device

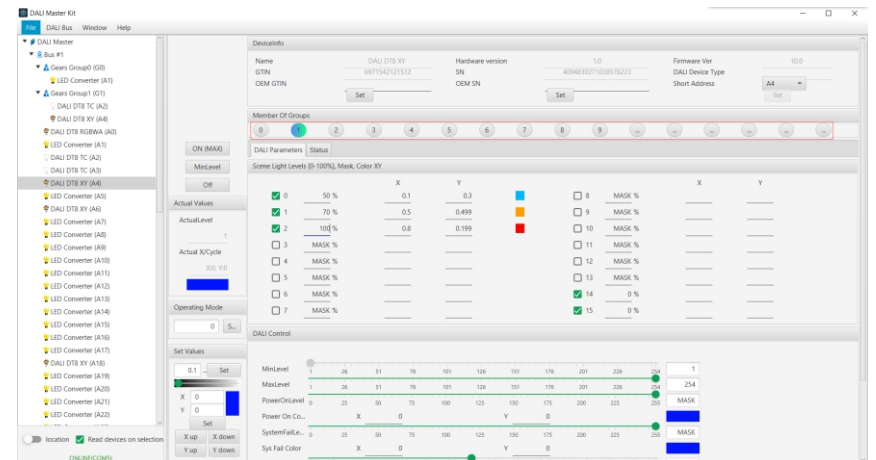

Figure 8 DALI Group Configuration for DT8 XY Device

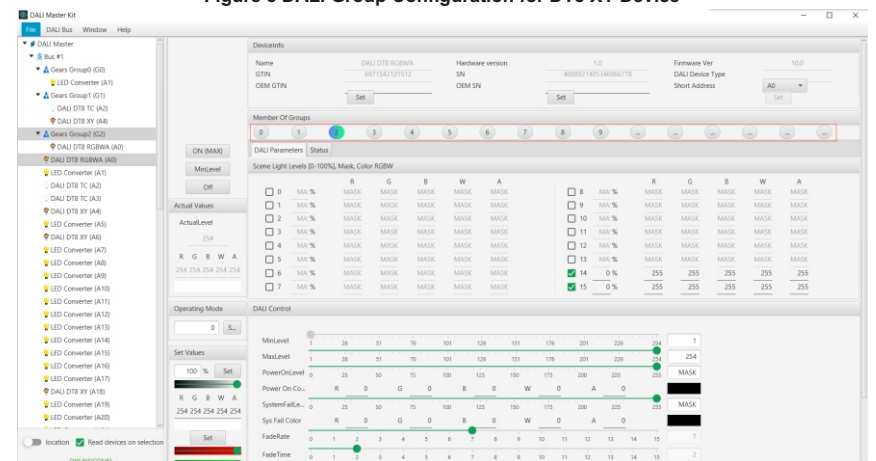

Figure 9 DALI Group Configuration for DT8 RGB Device

3.2. For DALI group configuration of DALI devices on Bus #2, please refer to the operations of Bus #1.

#### 4. Configuring DALI Scenes of DALI Devices

4.1. Click to choose a DALI Device under Bus #1 on the left column of main window, the DALI configuration parameters of this device will be shown on the right side. The configuration item “Scene Light Levels” under “DALI Parameters” is to configure maximum 16 DALI scenes of a DALI device. Click to tick the scene numbers, then the scenes can be configured as shown in Figure 10.

4.2. For DT6 device, just brightness level should be set for a DALI scene. After setting the parameter of the scenes, Click on “Write” button on bottom right of the window to write the scenes to the DALI device as shown in Figure 10.

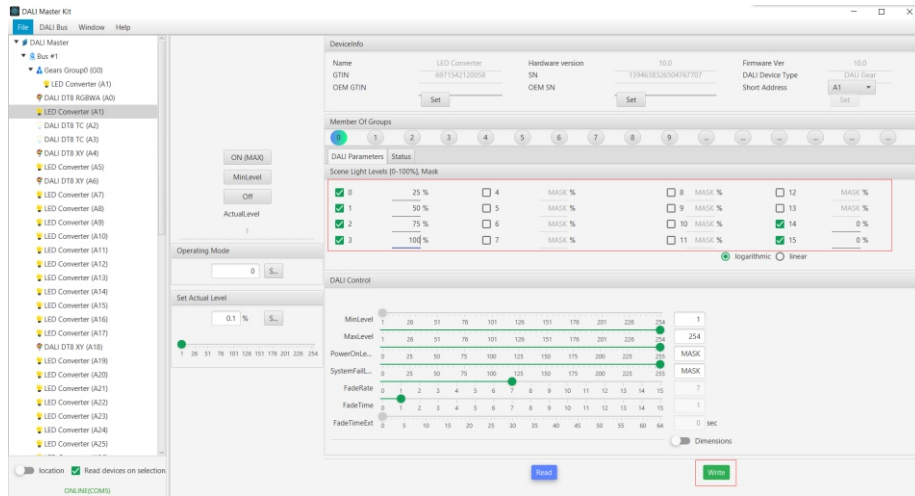

Figure 10 DALI Scene Configuration for DT6 Device

4.3. For DT8 Tc device, brightness level & color temperature should be set for a DALI scene. After setting the parameters of the scenes, Click on “Write” button on bottom right of the window to write the scenes to the DALI device as shown in Figure 11.

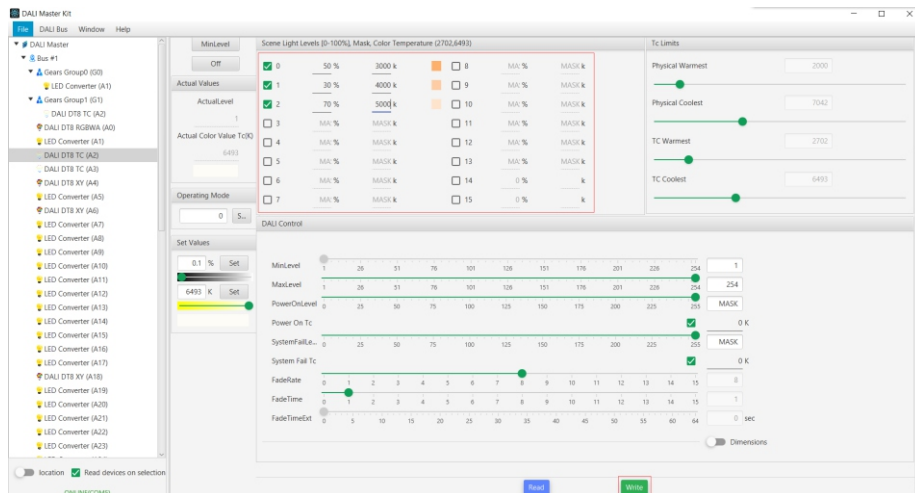

Figure 11 DALI Scene Configuration for DT8 Tc Device

4.4. For DT8 XY device, brightness level, X coordinate value and Y coordinate value should be set for a DALI scene. After setting the parameters of the scenes, Click on “Write” button on bottom right of the window to write the scenes to the DALI device as shown in Figure 12.

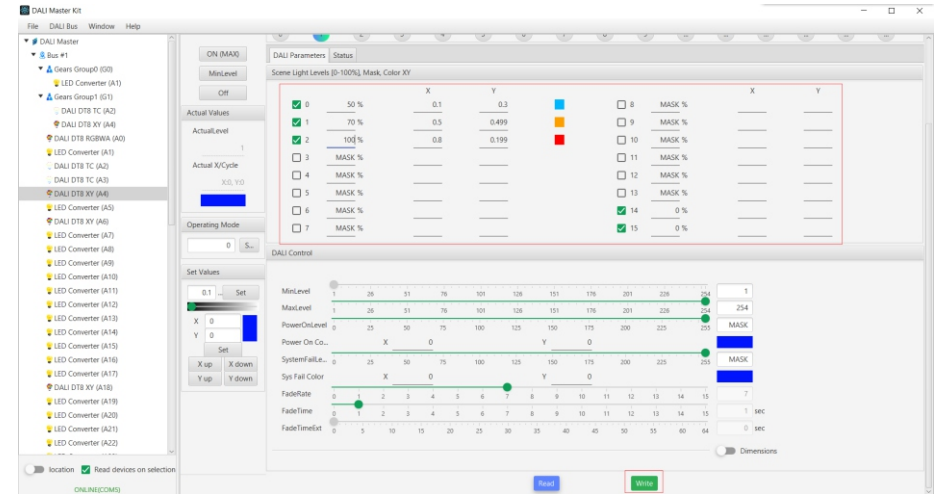

Figure 12 DALI Scene Configuration for DT8 XY Device

4.5. For DT8 RGB device, brightness level, values of R, G, B (maximum 254) should be set for a DALI scene. After setting the parameters of the scenes, Click on “Write” button on bottom right of the window to write the scenes to the DALI device as shown in Figure 13.

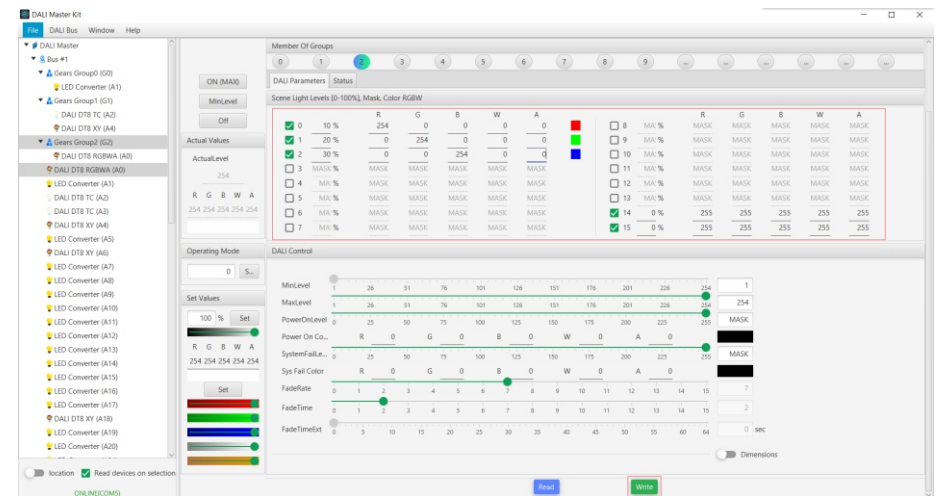

Figure 13 DALI Scene Configuration for DT8 RGB Device

4.6. For DALI scene configuration of DALI devices on Bus #2, please refer to the operations of Bus #1.

# KNX Programming

## 1. Wiring and Preparation

Do wiring according to the wiring diagram and power on. Download and install the “ETS5” software. Make sure the DALI programming of the 2 channels DALI has already been done.

## 2. Import Device & Create Project

2.1. Import device and database, click on “Catalogs” on the top, then click on “Import” to import the device database as shown in Figure 14.

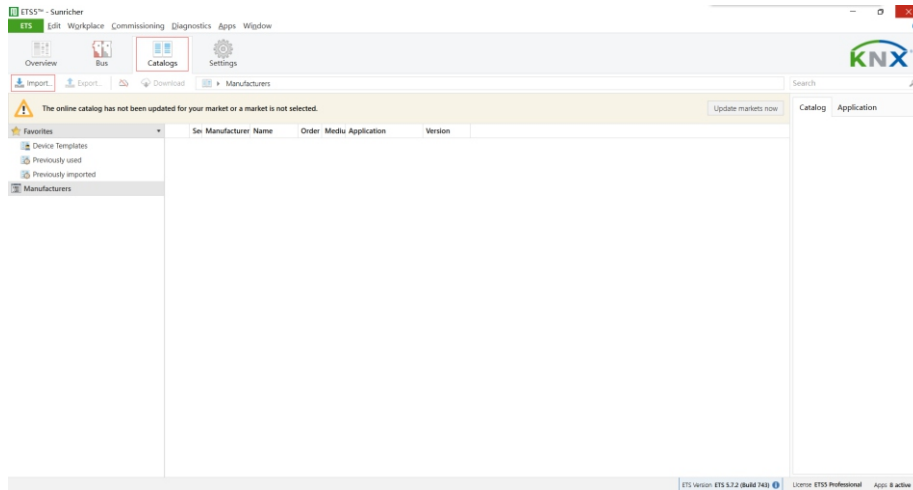

Figure 14

2.2. Choose and click on the database file of the gateway from the computer as shown in Figure 15.

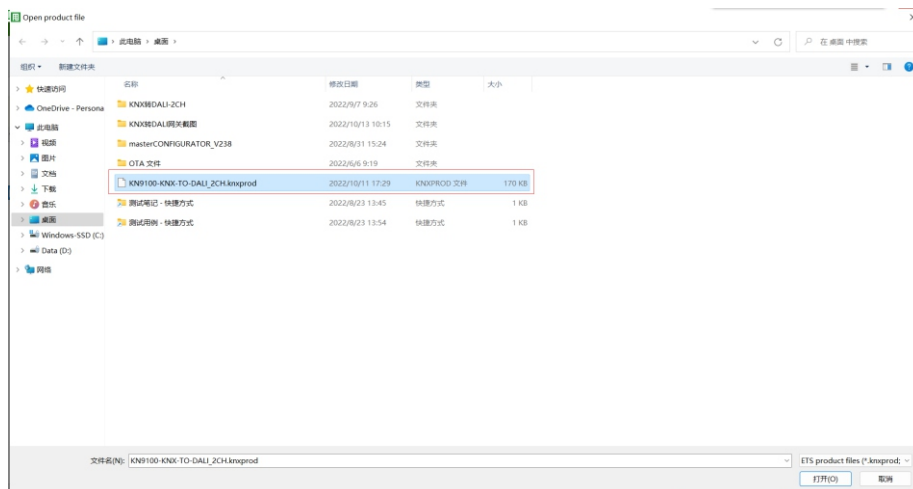

Figure 15

2.3. Database is imported successfully, click on “OK” button as shown in Figure 16.

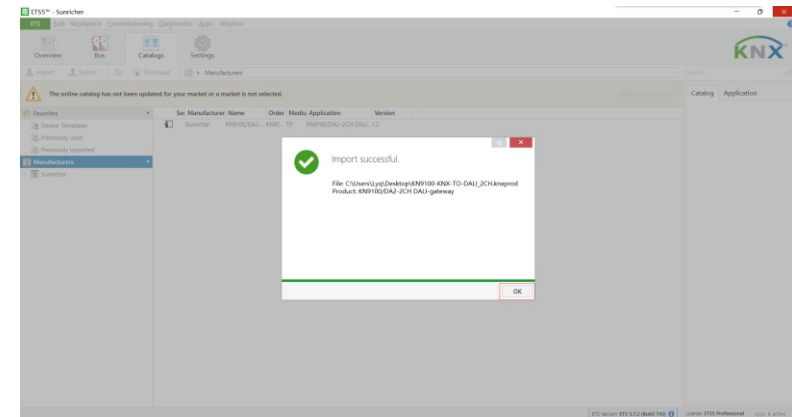

Figure 16

2.4. Create project, here we take KNX IP interface as an example. Click on “BUS” on the top, then click on “Interfaces” under “Connections” on the left column. The KNX IP interface will be discovered automatically and shown under “Discovered Interfaces” as shown in Figure 17.

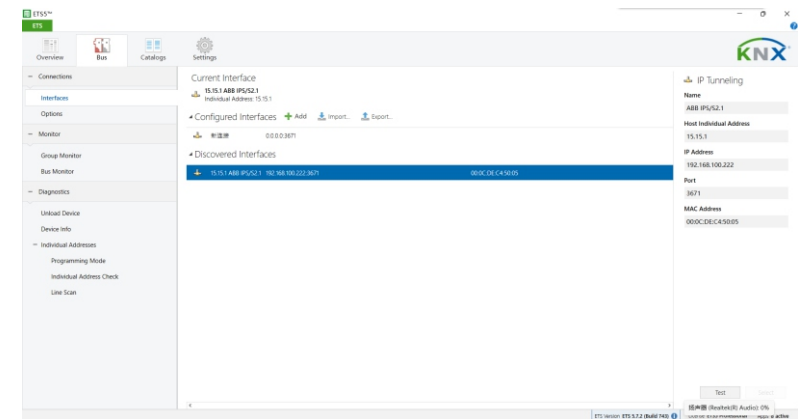

Figure 17

2.5. Click to choose the interface under “Current Interface” as shown in Figure 18.

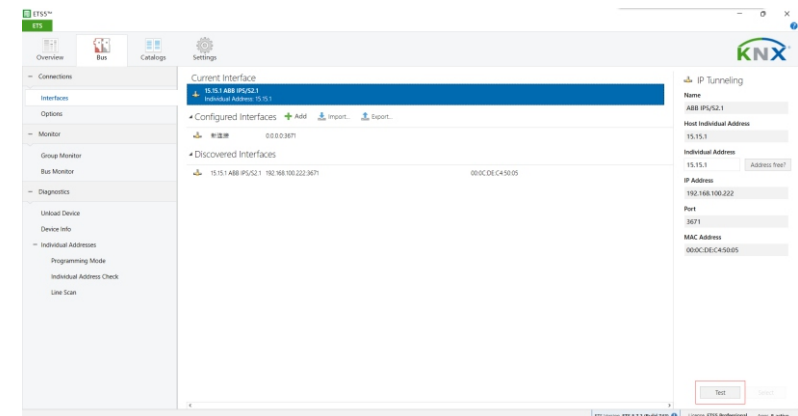

Figure 18



### 3. KNX Programming

#### 3.1. Channels

The gateway controls 2 channels DALI: CH1 (Bus #1) & CH2 (Bus #2). Each control channel has General, ECG (each individual control gear), Group, and Scene channels as shown in Figure 25.

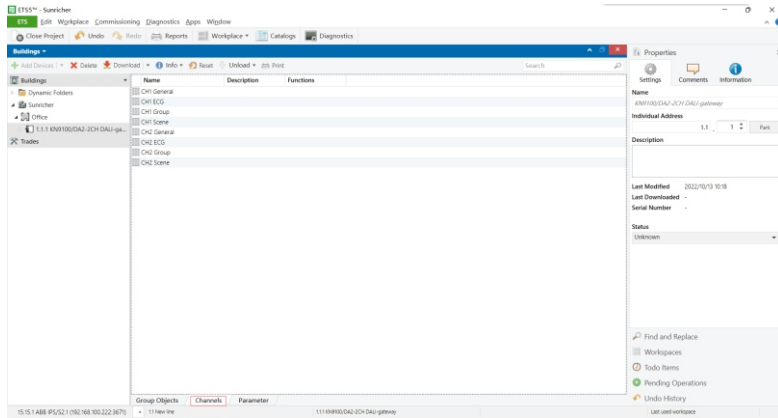

Figure 25

#### 3.2. Parameter

The parameter of General, ECG (each individual control gear), and Group of each control channel can be programmed separately. Following is the parameter programming operations of CH1, regarding CH2 parameter programming, please refer to CH1.

##### 3.2.1. CH1 General

**Reaction on DALI voltage failure:** means reaction when CH1 DALI voltage is lost, drop down and tick a value, available settings: "no change", "max. brightness value", "min. brightness value", "OFF" as shown in Figure 26.

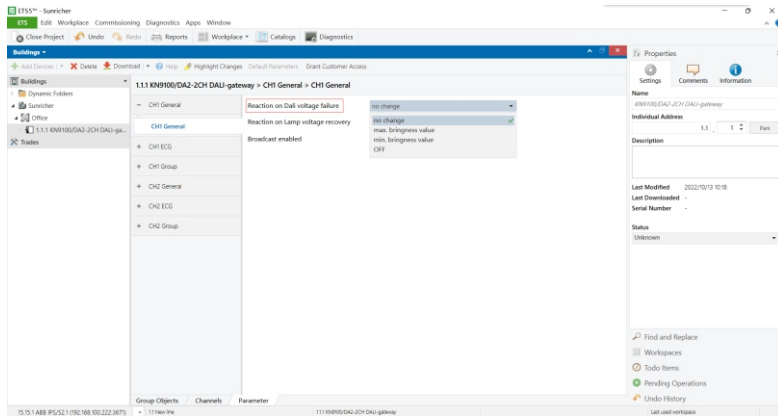

Figure 26

**Reaction on lamp voltage recovery:** means reaction when voltage of control gears of CH1 is reset, drop down and tick a value, available settings: "no change", "max. brightness value", "min. brightness value", "OFF" as shown in Figure 27.

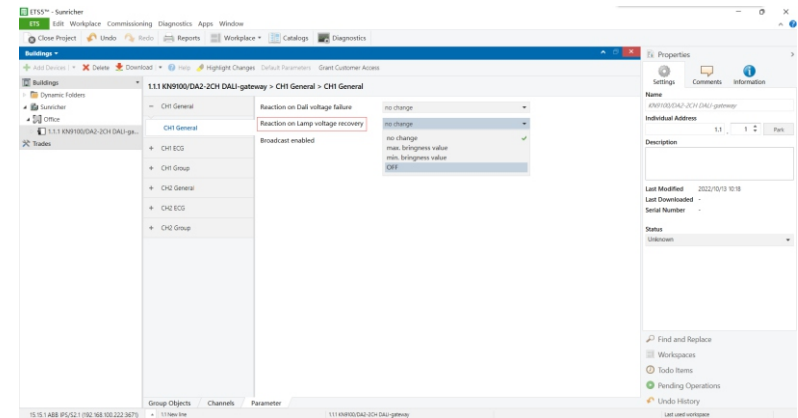

Figure 27

**Broadcast enabled:** this parameter is to set whether to enable the broadcast control of CH1, available settings: "no", "yes", if it is set as "yes", "All devices turn on value" needs to be set, available settings are "10%-100%", "min. brightness", "max. brightness", and "last brightness value" as shown in Figure 28.

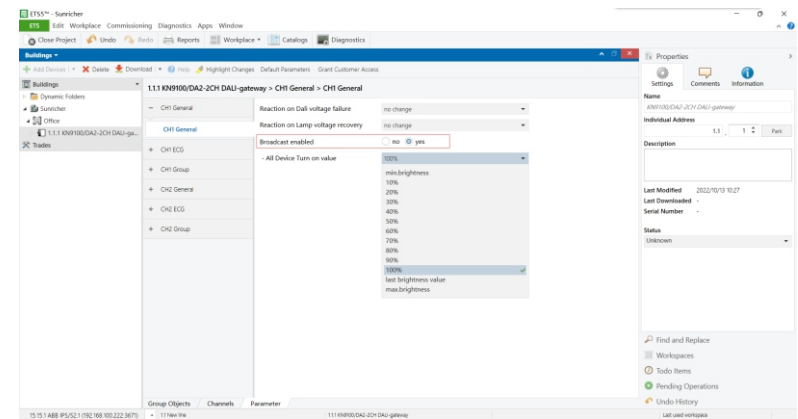

Figure 28

##### 3.2.1. CH1 ECG

CH1 ECG parameter means the parameter of the control gears connected to CH1. There are total 64 ECGs ECG01 to ECG64 as shown in Figure 29, 30, the 64 ECGs here mirror the 64 DALI control gears connected to CH1. **ECG01 to ECG64 correspond to DALI control gear with address A0 to address A63.**

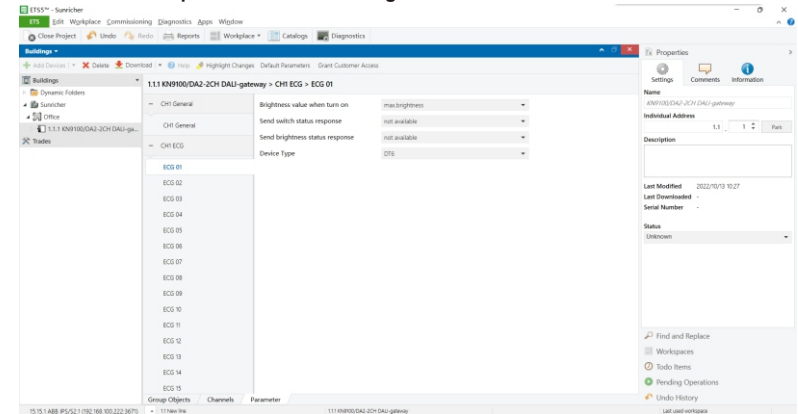

Figure 29

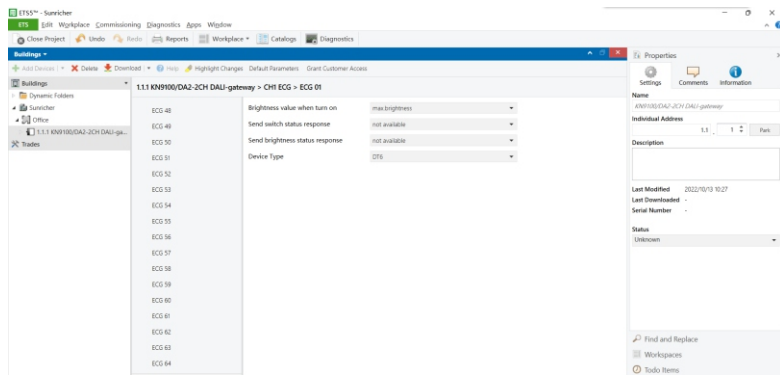

Figure 30

For each ECG, there are several parameters can be set, following is the setting of ECG1 as an example.

**Brightness value when turn on:** means brightness value when the ECG is turned on, drop down and tick a value, available settings are “10%-100%”, “min. brightness”, “max. brightness”, and “last brightness value” as shown in Figure 31.

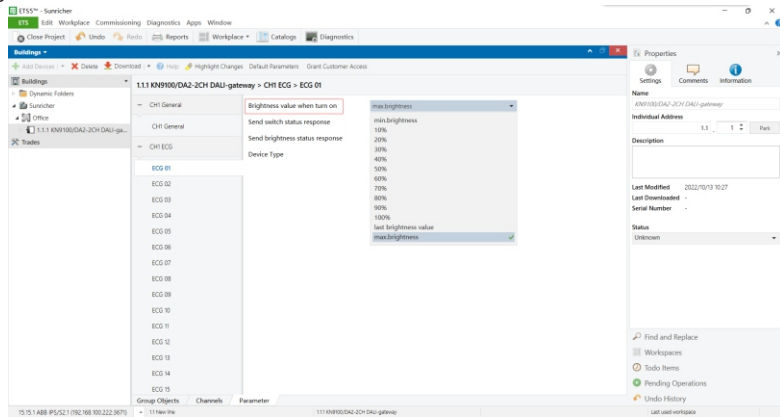

Figure 31

**Send switch status response:** means when to report the switch status of the ECG, drop down and tick a value, available settings are “not available”, “only on read request”, and “on change of status” as shown in Figure 32.

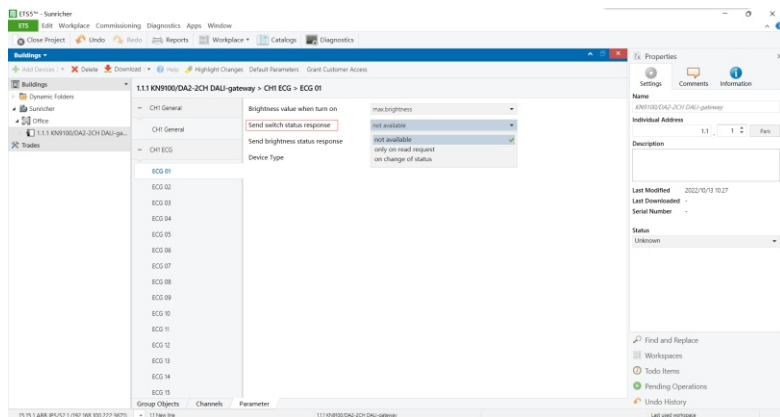

Figure 32

**Send brightness status response:** means when to report the brightness status of the ECG, drop down and tick a value, available settings are “not available”, “only on read request”, and “on change of status” as shown in Figure 33.

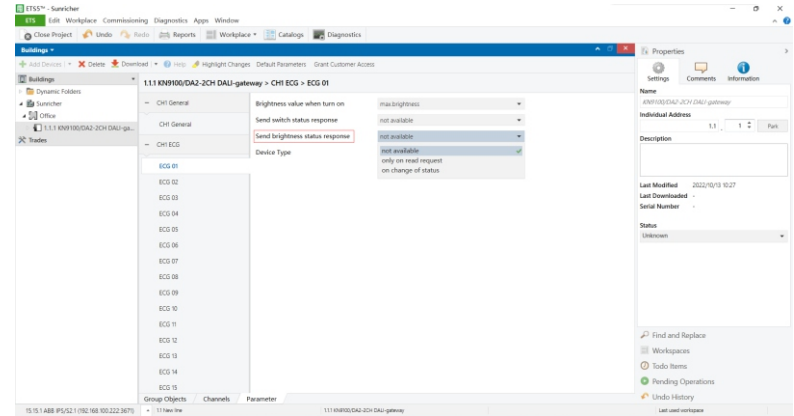

Figure 33

**Device Type:** means the device type of the ECG, drop down and tick a value, available settings are “DT6”, “CT”, “RGB” and “XY” as shown in Figure 34. This parameter should be set according to the device type of the discovered corresponding DALI i-ch control gear in DALI programming part. Corresponding DALI device types of the 4 values are as follows: “DT6” corresponds to “LED Converter” type in DALI Master, “CT” corresponds to “DT8 Tc” type in DALI Master, “RGB” corresponds to “DT8 RGB” type in DALI Master, “XY” corresponds to “DT8 XY” type in DALI Master.

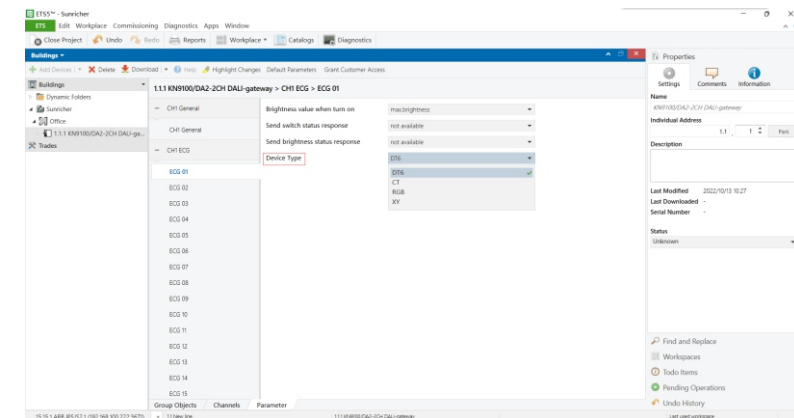

Figure 34

### 3.2.2. CH1 Group

CH1 Group parameter means the parameter of the groups of CH1. There are total 16 groups 01 to 16 as shown in Figure 35, 36, the 16 groups here mirror the 16 DALI groups of CH1. **Group 01 to Group 16 correspond to DALI group number 0 to 15.**



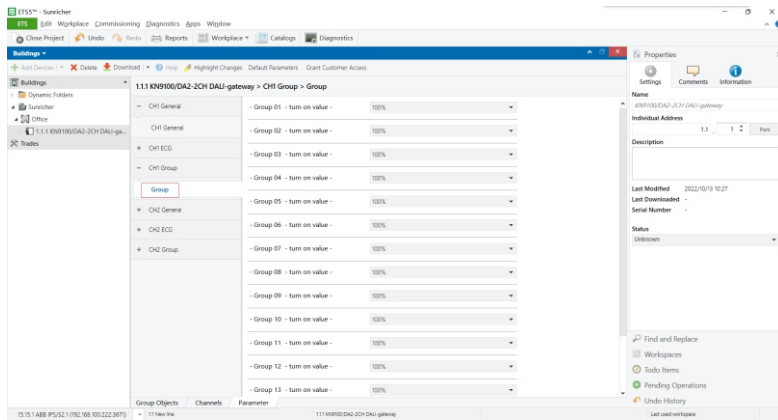

Figure 35

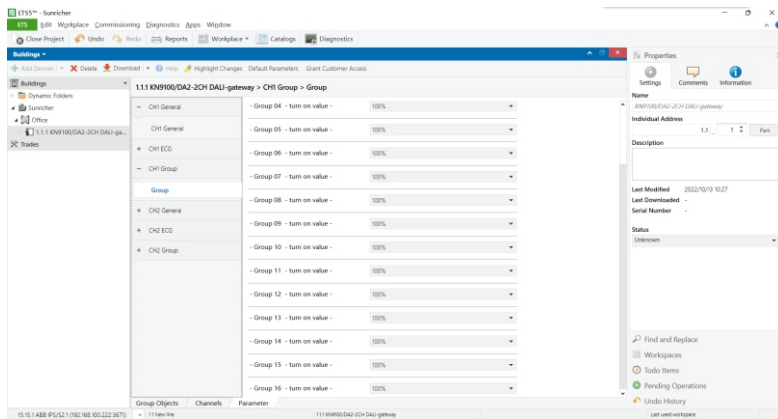

Figure 36

For each group, one parameter can be set, following is the setting of Group 01 as an example.

**Turn on value:** means brightness value when the group is turned on, drop down and tick a value, available settings are “10%-100%”, “min. brightness”, “max. brightness”, and “last brightness value” as shown in Figure 37.

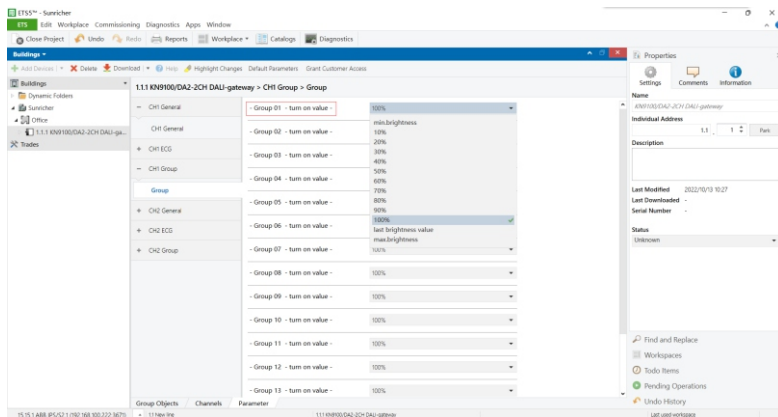

Figure 37

### 3.3. Group Objects

Group Objects mean the various functions of the gateway. CH1 & CH2 Group Objects can be programmed separately. Following is the Group Objects description of CH1. Regarding CH2 Group Objects, please refer to the description of CH1.

#### 3.3.1. Group Objects of General & Broadcast (As shown in Figure 38)

##### General Group Objects

Ballast fault number: the number of fault ballasts  
 Lamp fault number: the number of fault lamps  
 Device Count: the number of devices

##### Broadcast Group Objects

Switching: broadcast switching  
 Relative dimming: broadcast relative dimming  
 Absolute dimming: broadcast absolute dimming  
 Color Temp(K): broadcast color temperature value  
 RGB: broadcast RGB value  
 XY: broadcast XY coordinate value

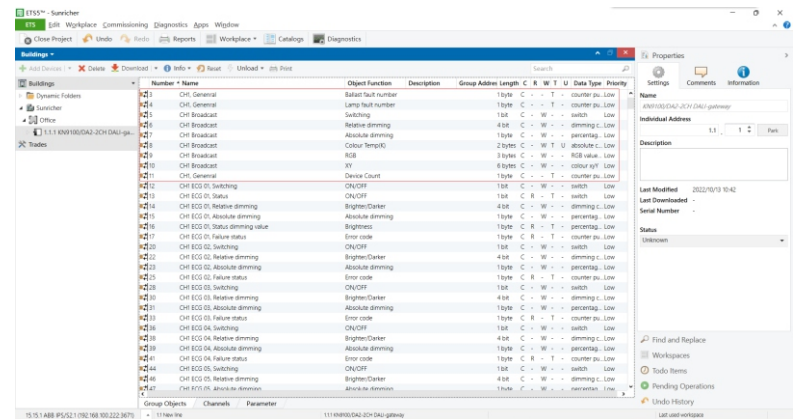

Figure 38

#### 3.3.2. Group Objects of ECG

There are total 64 ECGs 01-64, each ECG can be programmed separately. Depending on the ECG device type configured in the parameter of ECG, Group Objects of different device types will be different. Following is the Group Objects of ECG 01 as an example, for other ECGs, please refer to ECG 01.

**Note:** here the 64 ECGs 01-64 mirror DALI control gears with addresses A0-A63.

**If ECG 01 device type parameter is configured as DT6, Group Objects are as shown in Figure 39:**

Switching: ECG switching  
 Status: ECG on/off status feedback  
 Relative dimming: ECG relative dimming  
 Absolute dimming: ECG absolute dimming  
 Status dimming value: ECG dimming value status feedback  
 Failure status: ECG failure status feedback



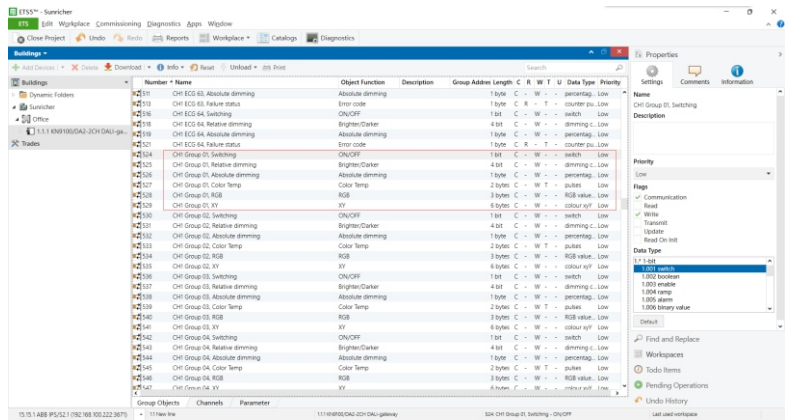

Figure 43

### 3.3.3. Group Objects of Scene

There are total 16 Scenes 01-16, the Group Objects of scene are used to recall the configured 16 DALI scenes, the Group Objects of scene are as shown in Figure 44.

**Note:** here the 16 scenes 01-16 mirrors the configured DALI scene numbers 0-15.

#### Group Objects of Scene:

- Scene 8bit, Scene No.: directly recall scene numbers 01-16 (corresponding to DALI scene 0-15)
- Scene 1bit, Recall 01/02: send data 0/1 to recall scene number 01/02 (corresponding to DALI scene 0/1)
- Scene 1bit, Recall 03/04: send data 0/1 recall scene number 03/04 (corresponding to DALI scene 2/3)
- Scene 1bit, Recall 05/06: send data 0/1 recall scene number 05/06 (corresponding to DALI scene 4/5)
- Scene 1bit, Recall 07/08: send data 0/1 recall scene number 07/08 (corresponding to DALI scene 6/7)
- Scene 1bit, Recall 09/10: send data 0/1 recall scene number 09/10 (corresponding to DALI scene 8/9)
- Scene 1bit, Recall 11/12: send data 0/1 recall scene number 11/12 (corresponding to DALI scene 10/11)
- Scene 1bit, Recall 13/14: send data 0/1 recall scene number 13/14 (corresponding to DALI scene 12/13)
- Scene 1bit, Recall 15/16: send data 0/1 recall scene number 15/16 (corresponding to DALI scene 14/15)

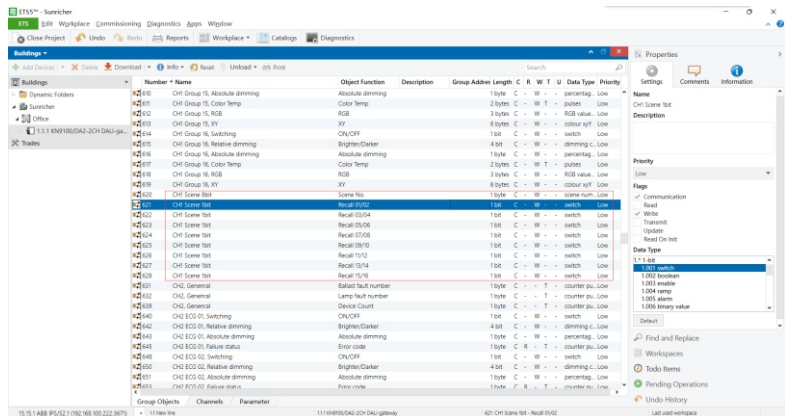
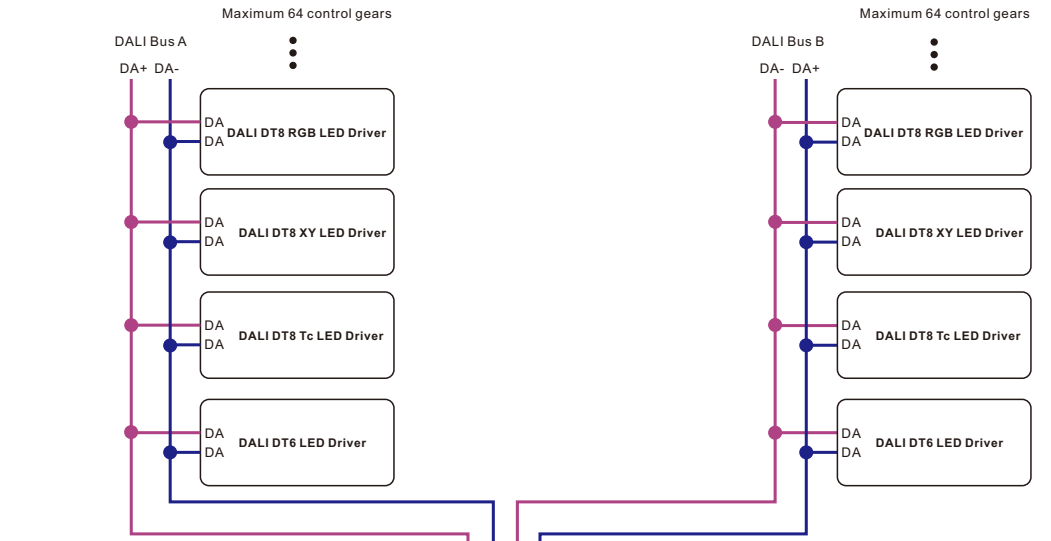
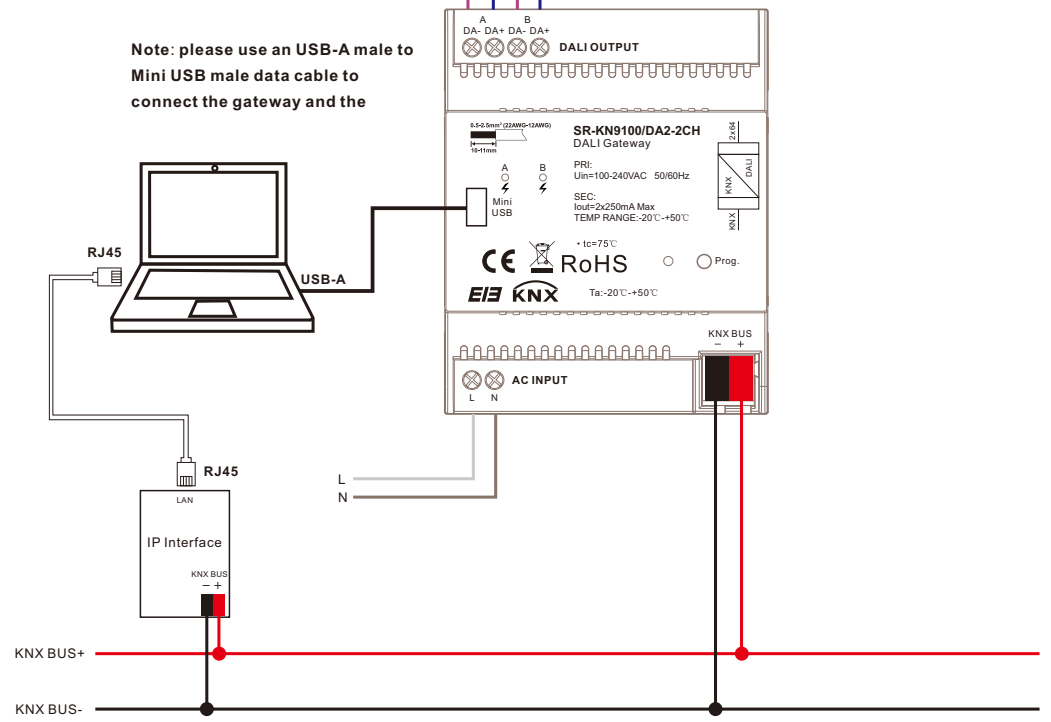

Figure 44

## Wiring diagram



**Note:** please use an USB-A male to Mini USB male data cable to connect the gateway and the



USB-A male to Mini USB male data cable:



**Product Dimension**

